



MIV Series



FEATURES

- Monolithic inorganic material construction.
- Closed magnetic circuit avoids crosstalk.
- Shapes and dimensions follow E.I.A. spec and available in various sizes.
- Excellent solder ability and heat resistance.
- AEC-Q200 qualified
- Lead-free reflow soldering as referenced in JEDEC J-STD 020D and
- Operating Temperature: -55~+125°C (Including self-temperature)

APPLICATION

-
-
- T- or -Filter
- Automotive equipment

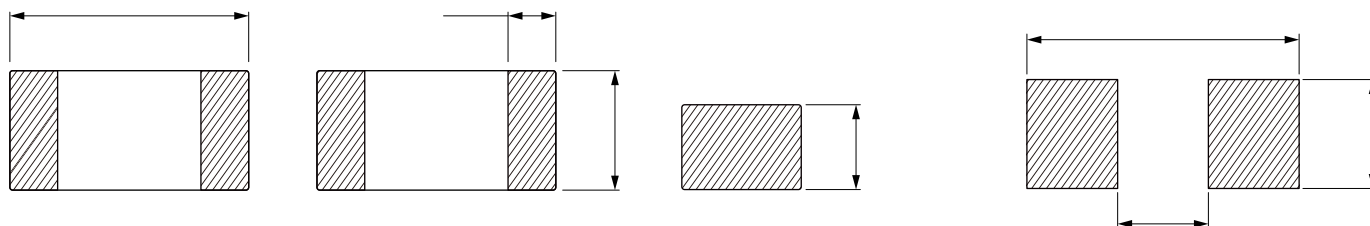

Part No	Inductance (uH)	Tolerance	Q Min.	Test Frequency Q (MHz)	Temperature Rise Current Max. (mA)	DC Resistance Max. ()	SRF Min. (MHz)	thickness H (mm)	Parking (pcs)
MIV2012-47NK	0.047	±10%	15	50	300	0.20	320	0.85±0.2	4000
MIV2012-R10K	0.10	±10%	20	25	250	0.30	235	0.85±0.2	4000
MIV2012-R12K	0.12	±10%	20	25	250	0.30	220	0.85±0.2	4000
MIV2012-R15K	0.15	±10%	20	25	250	0.40	200	0.85±0.2	4000
MIV2012-R18K	0.18	±10%	20	25	250	0.40	185	0.85±0.2	4000
MIV2012-R22K	0.22	±10%	20	25	250	0.50	170	0.85±0.2	4000
MIV2012-R27K	0.27	±10%	20	25	250	0.50	150	0.85±0.2	4000
MIV2012-R33K	0.33	±10%	20	25	250	0.55	145	0.85±0.2	4000
MIV2012-R39K	0.39	±10%	25	25	200	0.65	135	0.85±0.2	4000
MIV2012-R47K	0.47	±10%	25	25	200	0.65	125	1.25±0.2	2000
MIV2012-R56K	0.56	±10%	25	25	150	0.75	115	1.25±0.2	2000
MIV2012-R68K	0.68	±10%	25	25	150	0.80	105	1.25±0.2	2000



Part No	Inductance (uH)	Tolerance	Q Min.	Test Frequency Q (MHz)	Temperature Rise Current Max. (mA)	DC Resistance Max. ()	SRF Min. (MHz)	thicness H (mm)
MIV2012-1R0K	1.0	±10%	45	10	50	0.40	75	0.85±0.2
MIV2012-1R5K	1.5	±10%	45	10	50	0.50	60	0.85±0.2
MIV2012-1R8K	1.8	±10%	45	10	50	0.60	55	0.85±0.2
MIV2012-2R2K	2.2	±10%	45	10	30	0.65	50	0.85±0.2
MIV2012-2R7K	2.7	±10%	45	10	30	0.75	45	1.25±0.2
MIV2012-3R3K	3.3	±10%	45	10	30	0.80	41	1.25±0.2
MIV2012-4R7K	4.7	±10%	45	10	30	1.00	35	1.25±0.2
MIV2012-100K	10	±10%	45	2	15	1.15	24	1.25±0.2

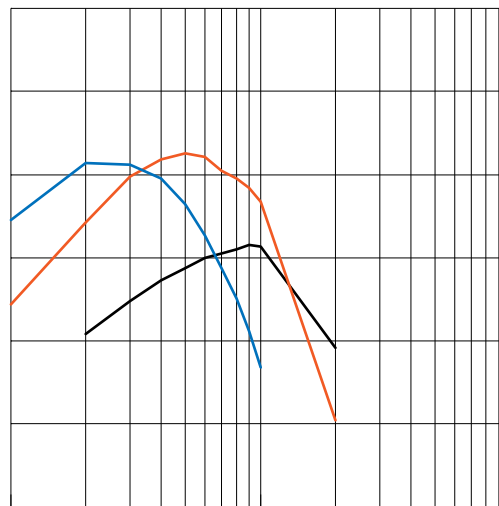
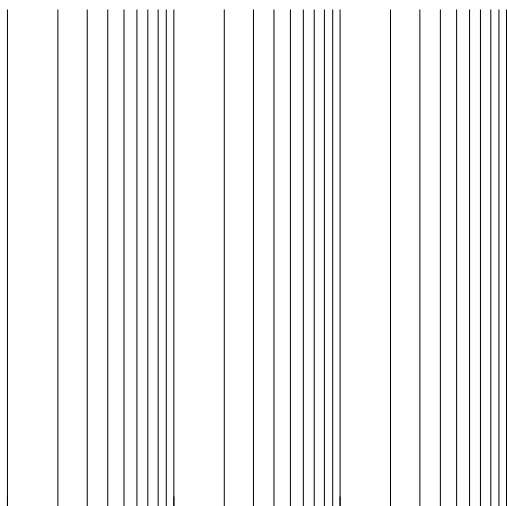

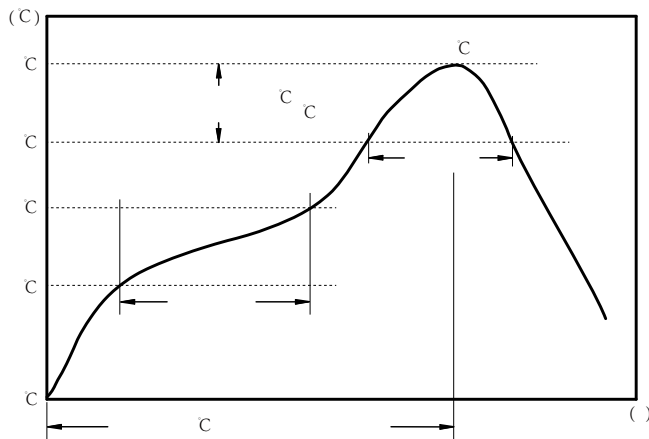

C
C
C

:

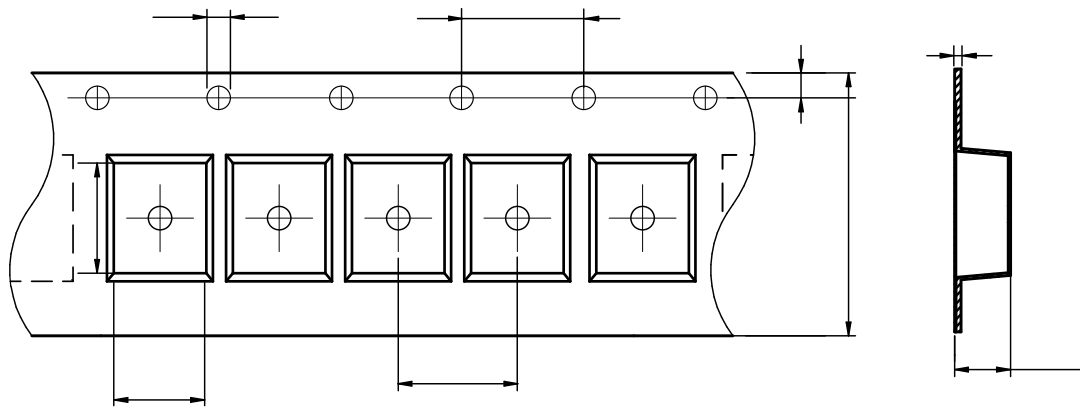

MIV2012	2.1±0.1	1.3/1.28±0.1	1.5±0.1	4.0±0.1	4.0±0.1	8.0±0.1	0.95/1.28±0.1	1.75±0.1	0.95/0.22±0.05

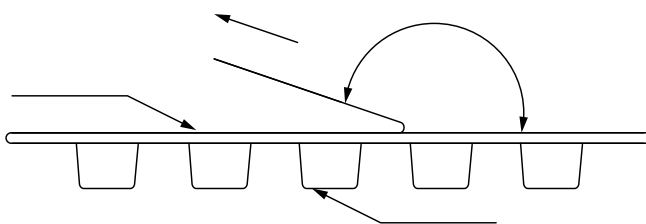

The peel force of top cover tape shall be between 0.15 to 0.58 N

:

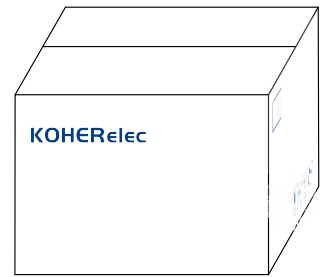
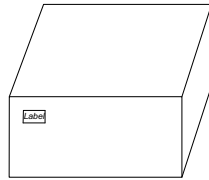
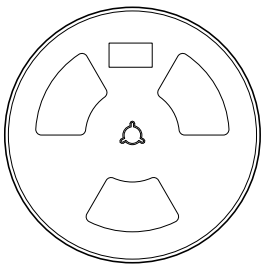
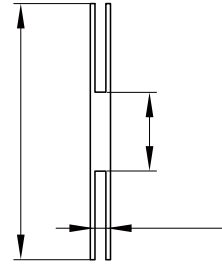
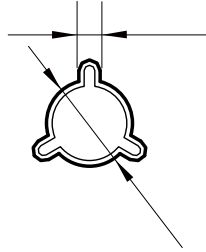
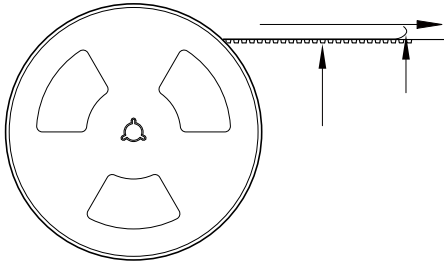

2000/4000 Pcs/Reel

5 Reel /Inner box(10K/20K Pcs)

8 Inner box/Carton box(80K/160K Pcs)

:

-
-
-
-
-
-
-
-
-