

FBE Series



CHARACTERISTICS

-
-
-
-
-

APPLICATION

-
-

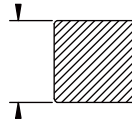
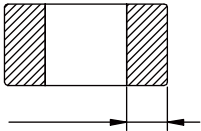

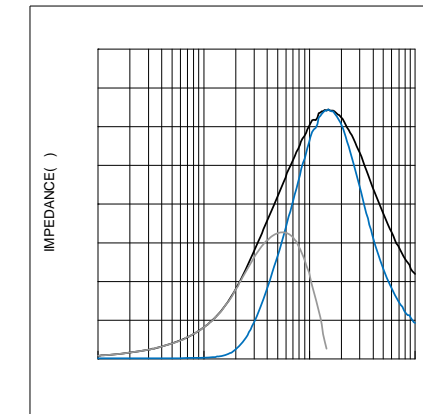
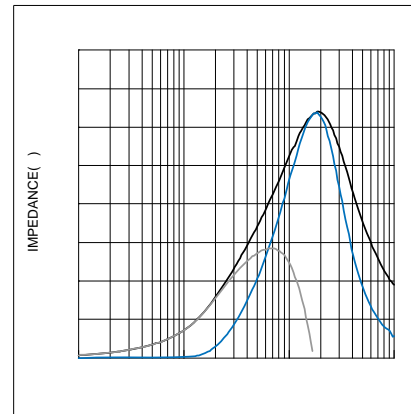
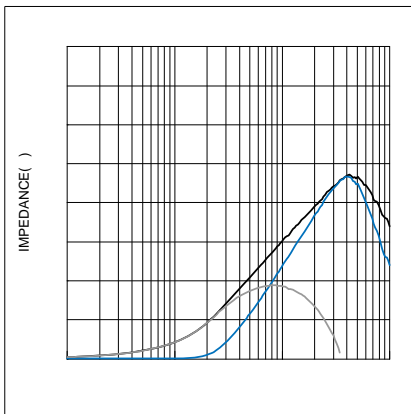
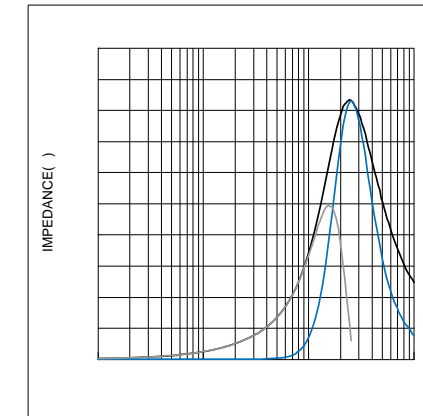
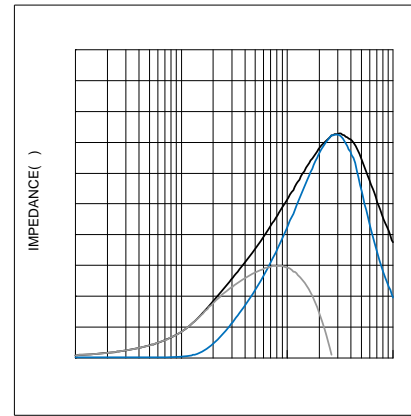
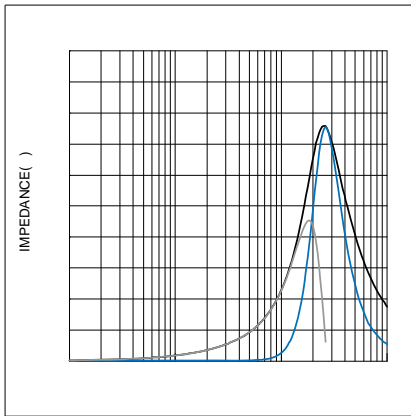
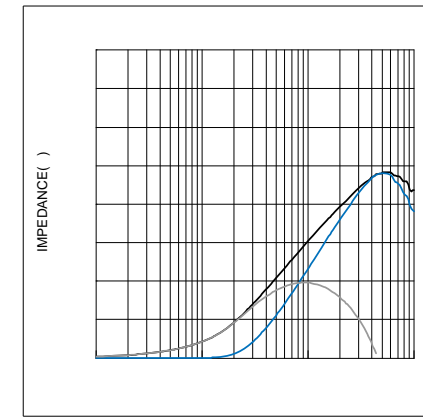
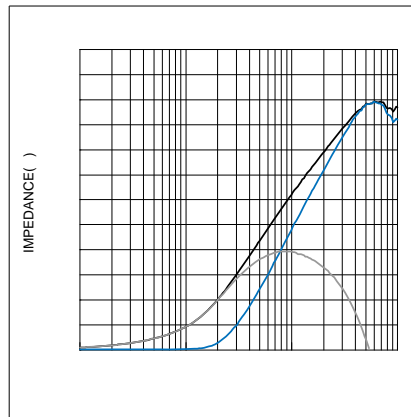
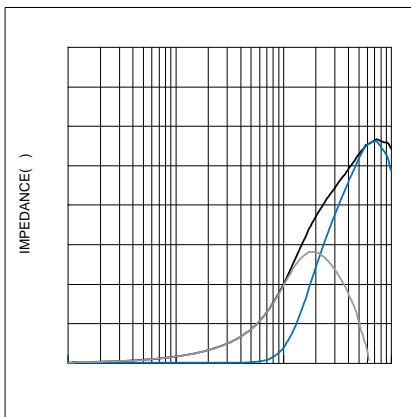
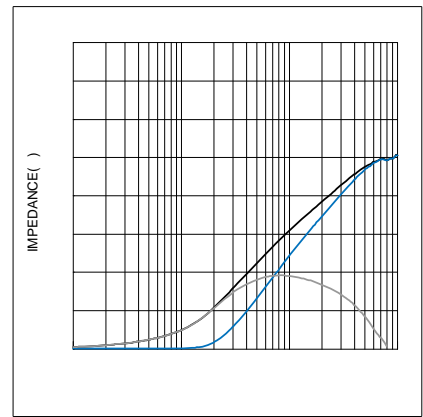
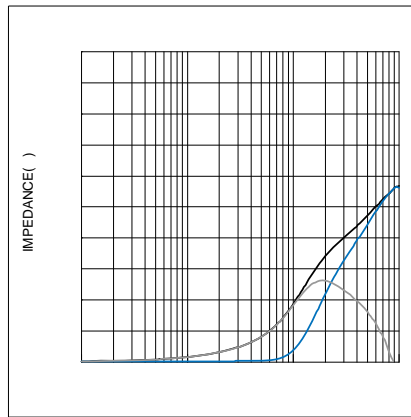
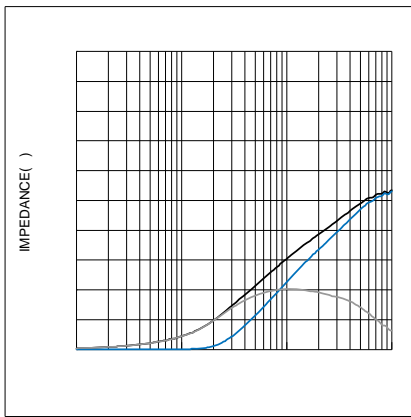

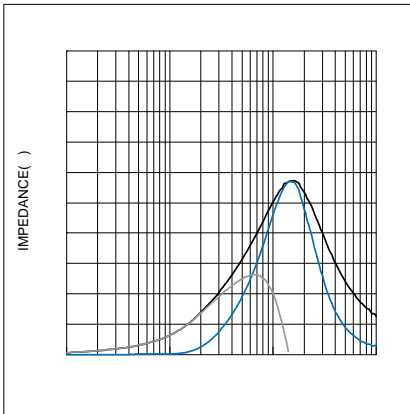

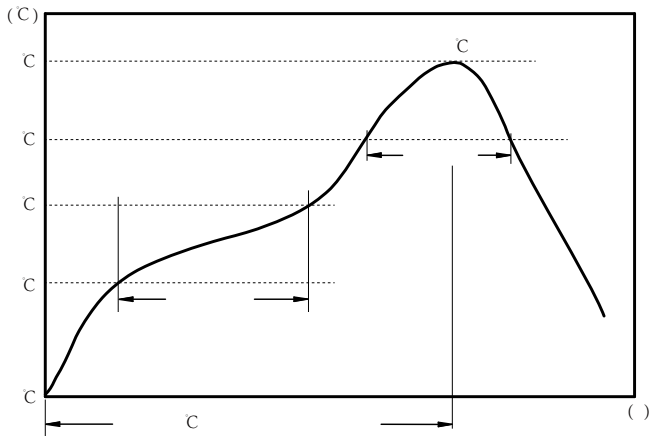

C
C
C

:

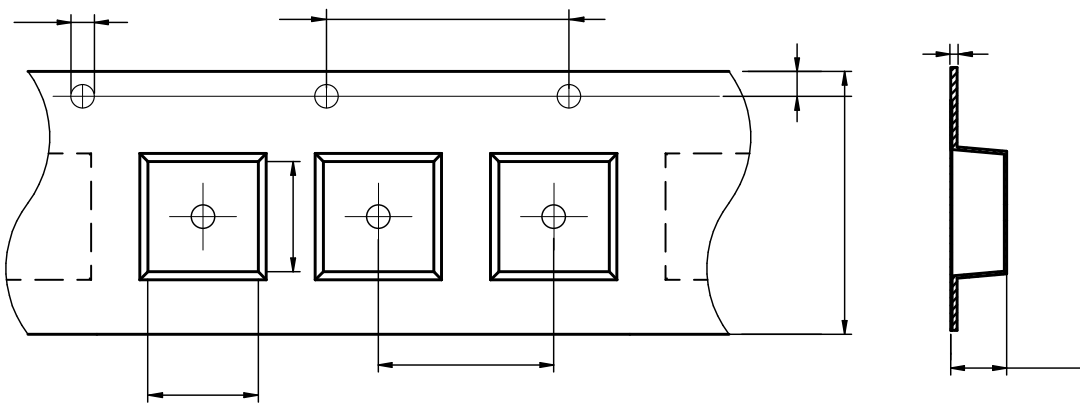

FBE0402	0.62 ± 0.03	1.12 ± 0.03	1.5 ± 0.1	4.0 ± 0.1	4.0 ± 0.1	8.0 ± 0.3	0.60 ± 0.03	1.75 ± 0.1	0.60 ± 0.03
---------	-----------------	-----------------	---------------	---------------	---------------	---------------	-----------------	----------------	-----------------

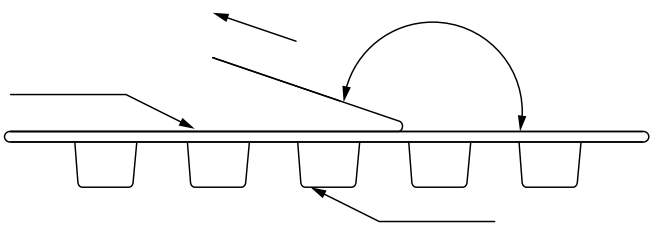

The peel force of top cover tape shall be between 0.14 to 0.58 N

:

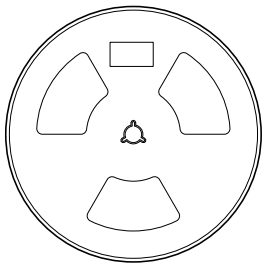
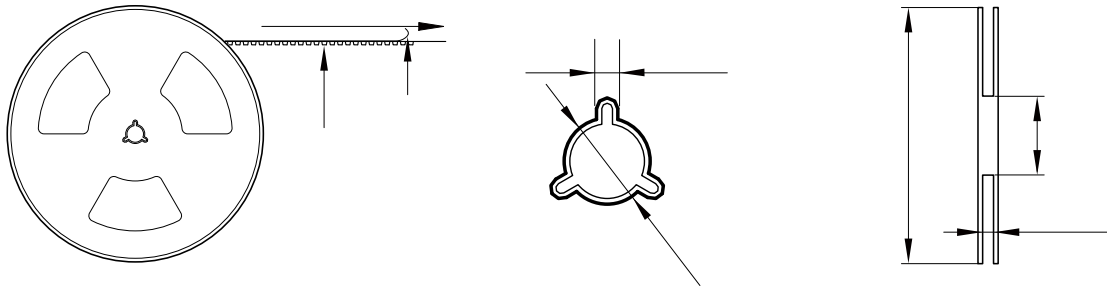

10000 Pcs/Reel

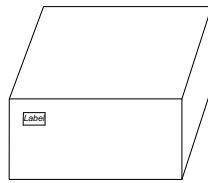

5 Reel /Inner box(50K Pcs)

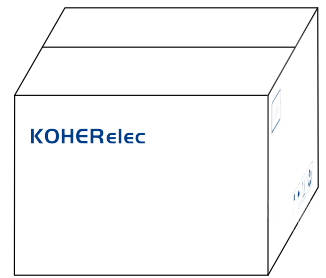

8 Inner box/Carton box(400K Pcs)

:

-
-
-
-
-
-
-
-
-