

BCMA Series

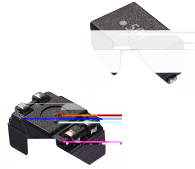

FEATURES

-
-
-
-

APPLICATIONS

-
-
-
-

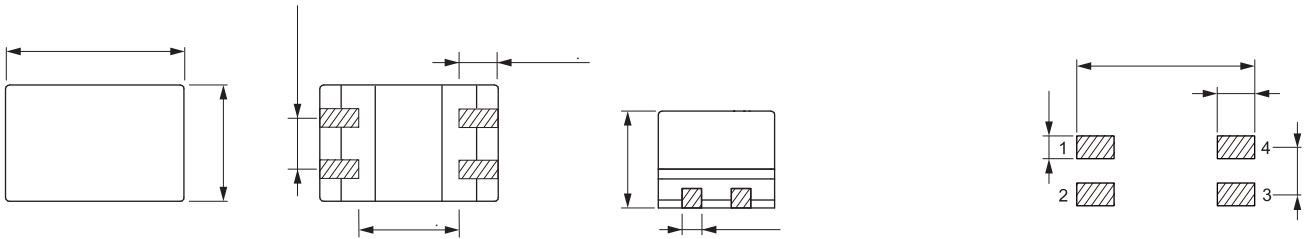

BCMA9250-100N	10	±30%	1.6	0.08	80	500	1KHz/0.1V
BCMA9250-S100N	10	±30%	1.6	0.08	80	500	1KHz/0.1V
BCMA9250-250N	25	±30%	1.0	0.12	80	500	1KHz/0.1V
BCMA9250-S250N	25	±30%	1.0	0.12	80	500	1KHz/0.1V
BCMA9250-400N	40	±30%	0.9	0.25	80	500	1KHz/0.1V
BCMA9250-S400N	40	±30%	0.9	0.25	80	500	1KHz/0.1V
BCMA9250-510N	51	±30%	1.0	0.16	80	500	1KHz/0.1V
BCMA9250-S510N	51	±30%	1.0	0.16	80	500	1KHz/0.1V
BCMA9250-251Y	250	±50%	1.2	0.13	80	500	100KHz/5mV
BCMA9250-501Y	500	±50%	1.0	0.15	80	500	100KHz/5mV
BCMA9250-102Y	1000	±50%	0.8	0.207	80	500	100KHz/5mV

BCMA9250-202Y	2000	±50%	0.60	0.42	80	500	100KHz/5mV
BCMA9250-472Y	4700	±50%	0.50	0.75	80	500	100KHz/5mV
BCMA9250-652Y	6500	±50%	0.40	0.95	80	500	10KHz/50mV
BCMA9250-103Y	10000	±50%	0.35	1.20	80	500	10KHz/50mV
BCMA9250-203Y	20000	±50%	0.20	2.60	80	500	10KHz/50mV

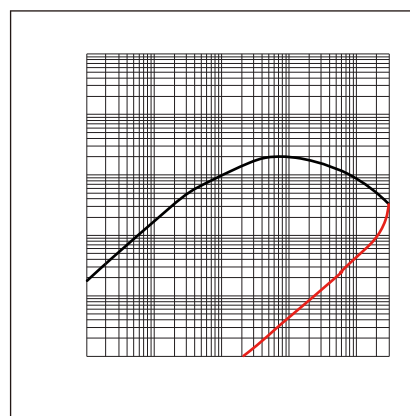
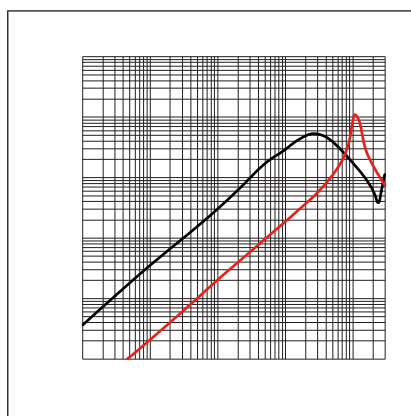
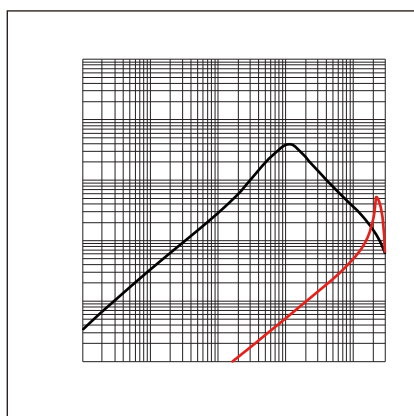
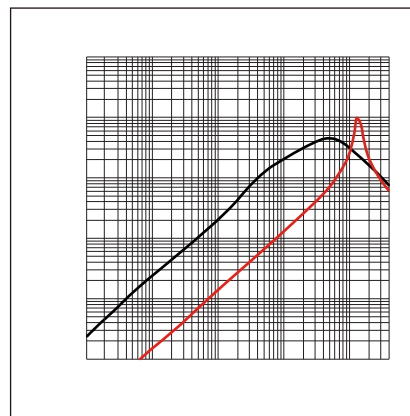
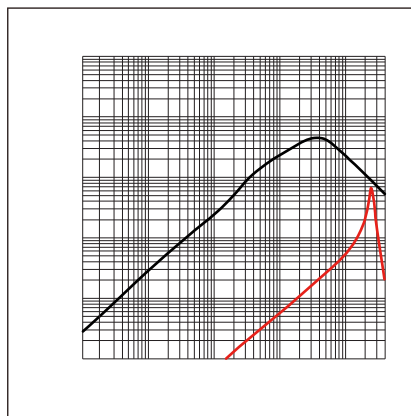
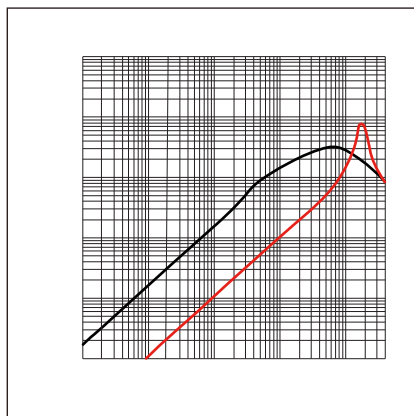
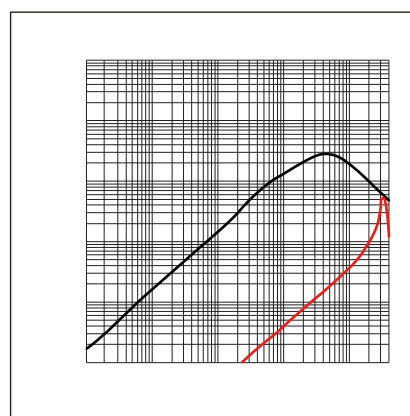
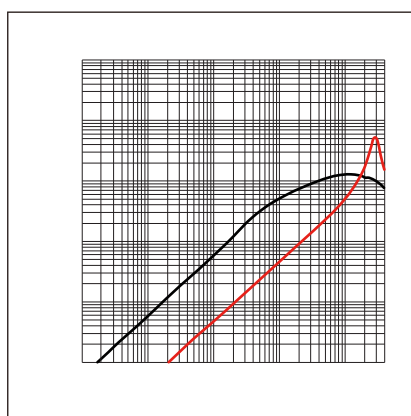
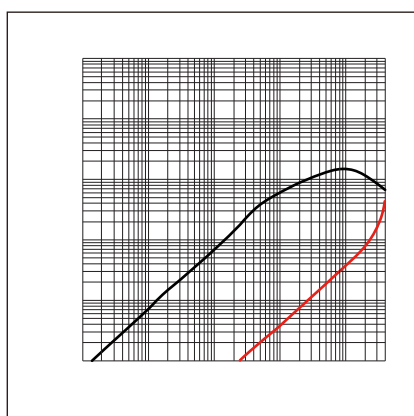

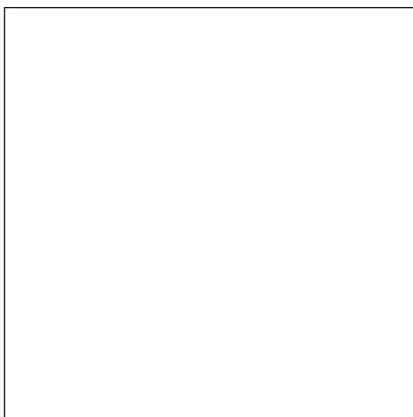
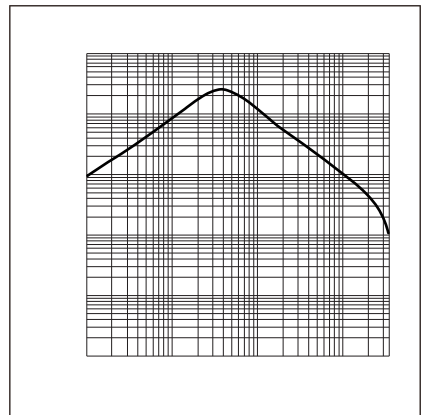
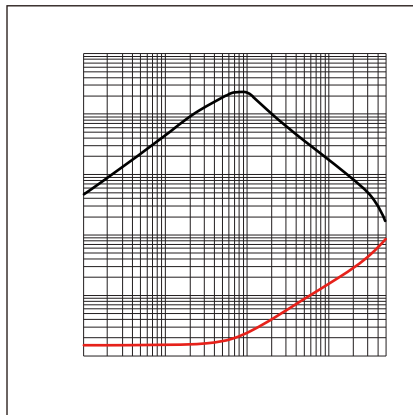
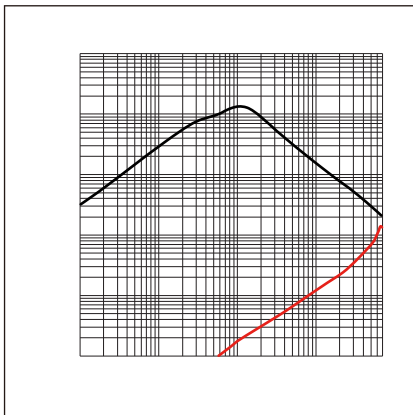
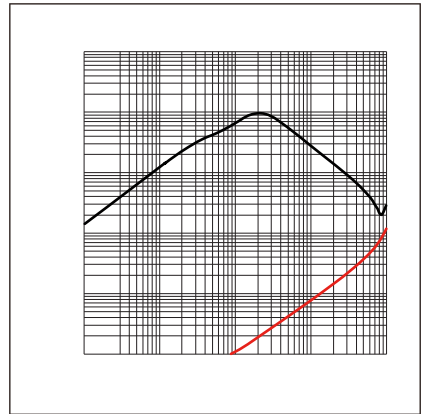
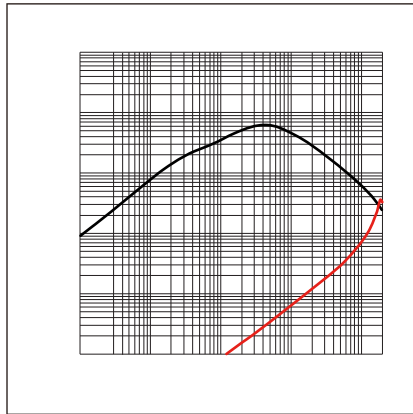
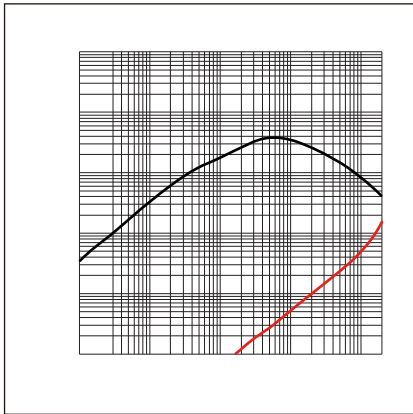

:

BCMA9250	6.5 typ	9.7 typ	1.5±0.1	4.0±0.1	12.0±0.1	16.0±0.3	5.7 ref.	1.75±0.1	0.4±0.1
----------	---------	---------	---------	---------	----------	----------	----------	----------	---------

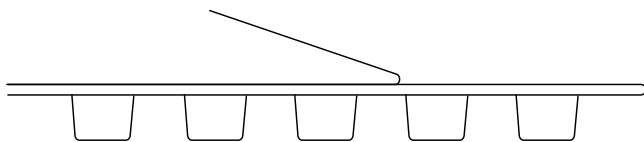

The peel force of top cover tape shall be between 0.1 to 1.3 N

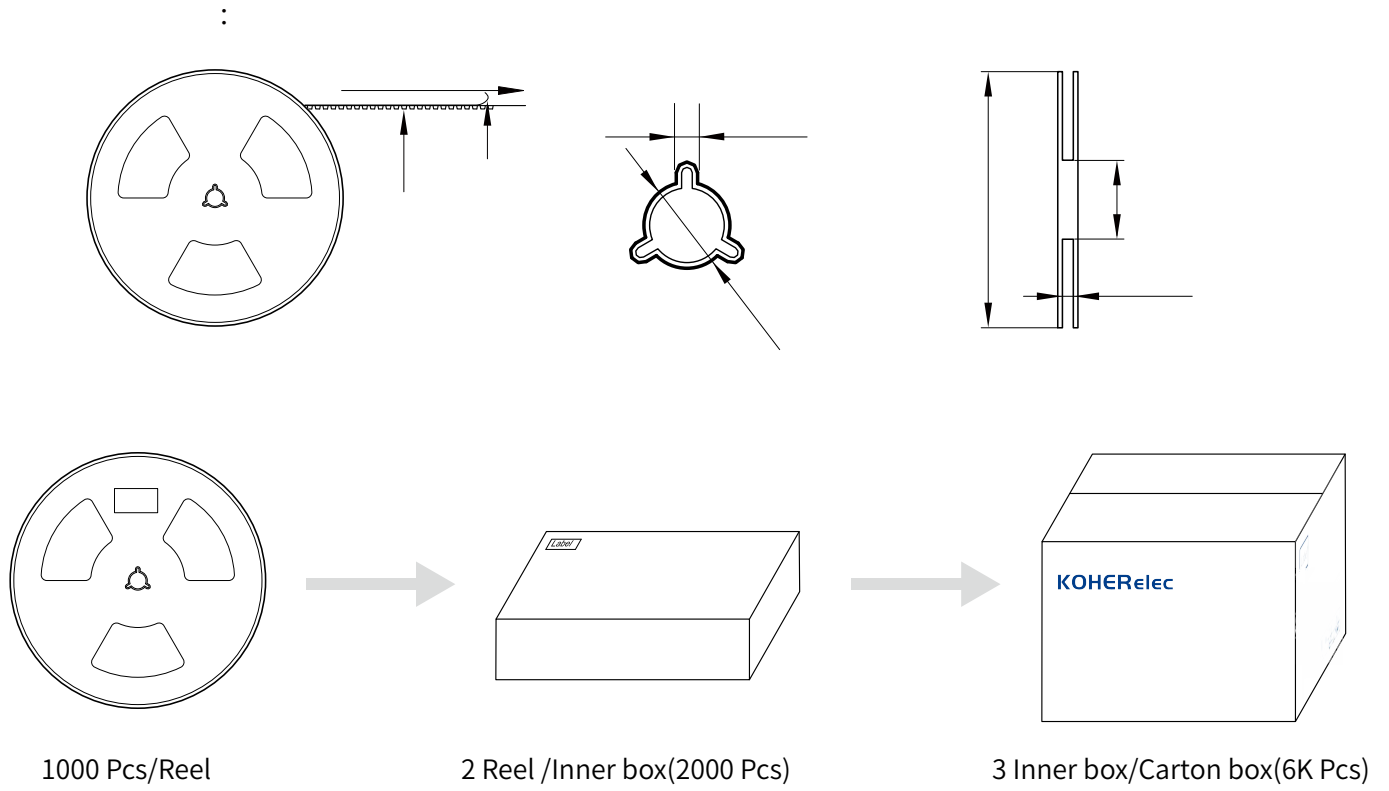

:

-
-
-
-
-
-
-
-
-
-